

netcam

User's Manual



www.stardot-tech.com



Table of Contents

Chapter 1 Configuration	5
1.1 Before You Start.....	5
1.2 What's Included and What's Required.....	5
1.3 Parts of NetCam.....	6
1.4 Connecting NetCam to a Network.....	6
1.5 An Overview of Network Connectivity.....	7
1.6 Connecting NetCam to a Modem.....	9
Chapter 2 Installation	10
2.1 Installing NetCam.....	10
2.2 Installing NetCam Outdoors.....	11
Chapter 3 Accessing NetCam	12
3.1 Viewing NetCam's Images.....	12
3.2 Accessing NetCam's Configuration Menus.....	12
3.3 Image Properties.....	12
3.4 Overlay Properties.....	16
3.5 FTP Properties.....	20
3.6 Applet Properties.....	24
3.7 Date/Time Properties.....	26
3.8 Network Properties.....	28
3.9 Dial-Out Properties.....	30
3.10 Security Properties.....	32
Chapter 4 Imaging Tips	34
4.1 Lighting.....	34
4.2 Image Processing Options.....	36
Chapter 5 NetCam Lenses	37
Troubleshooting Guide	39
Technical Support	39
Specifications	40

Chapter 1 Configuration

Congratulations on your purchase of a StarDot NetCam network camera with integrated web server. NetCam provides the highest quality live still images in a remote camera that can be connected to a network or a modem. With proper usage, NetCam will provide many years of quality remote imaging. We recommend that you read this manual carefully to completely understand NetCam's capabilities.

1.1 Before You Start

This manual guides you through the basic setup procedure for NetCam and provides a detailed resource of the camera's advanced options and capabilities.

Setting up NetCam consists of three steps. The first step is to configure NetCam's network or dial-out settings. The second step is to configure NetCam to upload images to a web server (this step is optional). The third step is the physical installation of the camera.

1.2 What's Included and What's Required

The NetCam package includes a NetCam camera, a lens, a wall mount, a power supply, a combo network/power cable, a null modem serial cable and the StarDot Tools software on CD-ROM. The Dial-Out package includes an external modem and modem cable (instead of the network cable). In order to use NetCam, you will need the following:

- Power source
- A computer – for configuring NetCam and for viewing NetCam images (viewing requires Java-enabled web browser)

Note: *A computer is not necessary to operate NetCam, only to configure it.*

- Network connectivity (LAN, cable modem, DSL, T-1, Dial-Up Internet Account, Satellite Modem, etc.)
- Web server space (only required when configured as Dial-Out ISP camera)

1.3 Parts of NetCam

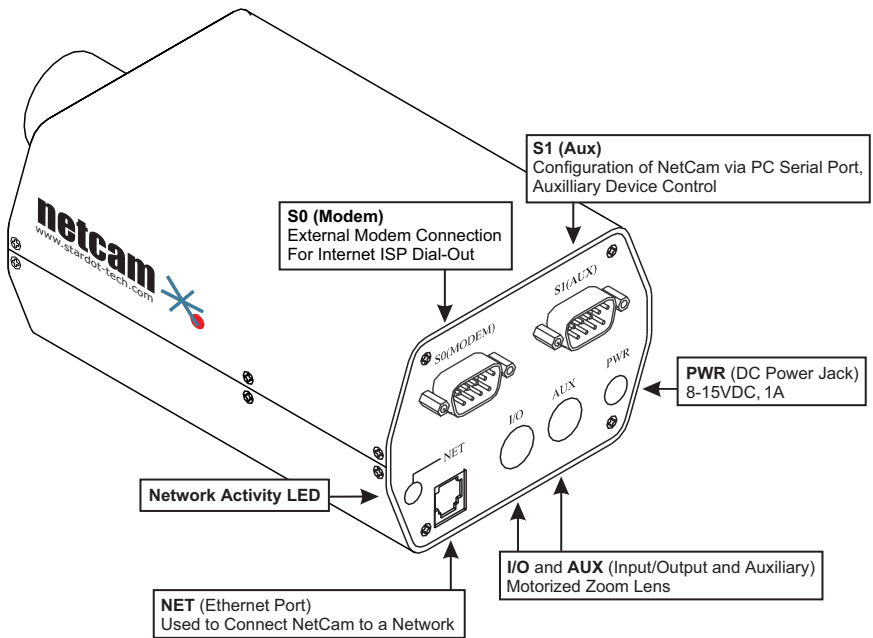

1.4 Connecting NetCam to a Network

The StarDot Tools software can be used find NetCam's IP address or to configure NetCam with a Setup Wizard.

- 1 Install the StarDot Tools software by inserting the CD-ROM and running `setup.exe` (it should run automatically).
- 2 If your network has a router or server that auto assigns IP addresses (DHCP), StarDot Tools will find NetCam's IP address and display it in the software. To access NetCam, simply double-click its IP address. Turn to Chapter 3 for assistance on configuring NetCam.
- 3 If your network does not auto-assign IP addresses, you'll need to configure NetCam via the included serial cable. Connect one end of the null model serial cable to the **S1** port of NetCam and the other end into an available serial port on your PC.
- 4 Connect NetCam into a network router, hub or switch with a standard CAT 5 network cable or with the included Combo Ethernet/Power Cable (see illustration).
- 5 In StarDot Tools, click the Setup Wizard button.
- 6 Follow the steps in the Setup Wizard. If you're unsure of some of the answers or you'd like more information on connecting NetCam to the Internet or your private network, read the next section, "An Overview of NetCam Connectivity".

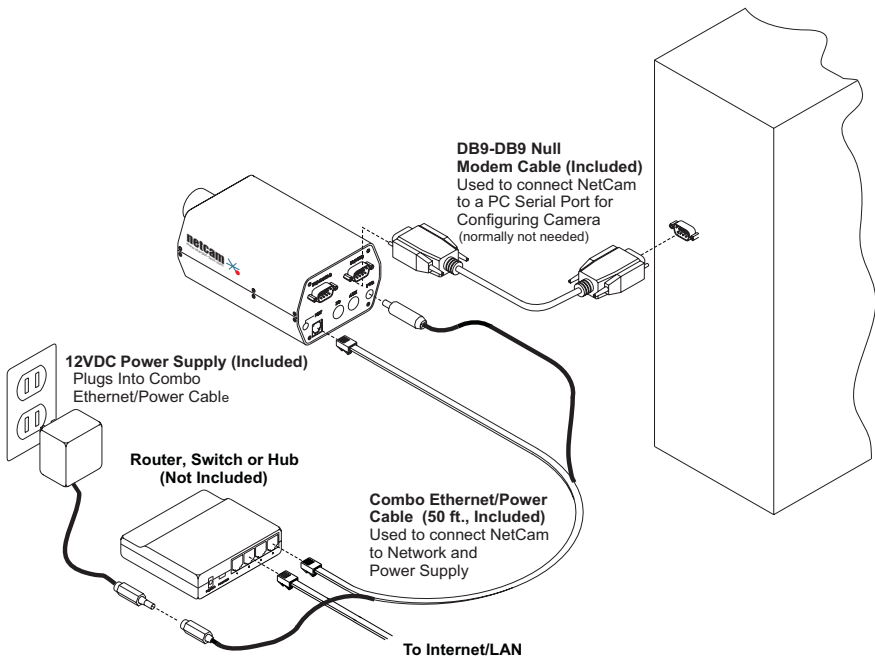

1.5 An Overview of Network Connectivity

A LAN or network connection is the simplest configuration for NetCam. NetCam simply needs an IP address (and other networking parameters) to make the live images and configuration menus accessible from any web browser on the network. There are two ways NetCam can be assigned an IP address: automatically or manually.

Automatic IP Assignment (DHCP)

NetCam is shipped in an automatic IP assignment mode called DHCP (Dynamic Host Configuration Protocol). If your network has a DHCP server (in most cases, a router), it will automatically assign the necessary network parameters to NetCam. Before you can access the camera, you will need to know which IP address was assigned to NetCam. Use the StarDot Tools software to find NetCam's IP address.

Manual IP Assignment

If you want to assign NetCam a permanent IP address, you will need the following information:

- IP Address (example: 192.168.1.5)
- Subnet Mask (example: 255.255.255.0)
- Gateway (example: 192.168.1.1)
- DNS Servers (example: 24.1.179.1, 24.1.179.2)

If you are installing NetCam on a company network, you will probably want to get this information from your system administrator.

The easiest way to configure NetCam manually is to connect NetCam to a serial port on your computer. Plug one end of the null modem serial cable into the **S1** port on the back of NetCam and the other end into an available 9-pin serial port on the back of your computer. Use the included StarDot Tools software to configure NetCam.

If you don't have a serial port or are using a non-Windows machine, you have a few options.

If NetCam is connected to a network with a DHCP server and your computer is not running Windows, you can log into your router (or whatever is acting as your DHCP server) and view the DHCP clients table. NetCam will have the MAC address starting with 00:30:F4. Take note of the IP address and enter it in your web browser. Click on the configuration link, visit the network tab and assign NetCam a manual IP address (outside of the router's DHCP range).

If NetCam is connected to a network without a DHCP server (IP addresses are not automatically assigned) and your computer is not running Windows, you'll have to manually assign NetCam an IP address. This requires terminal emulation software and the included null serial cable. On a Macintosh or on a Windows computer without a serial port, you'll need a USB RS-232 adapter.

To talk directly to NetCam via the included serial cable, set your terminal software to a bitrate of 38,400 (8/N/1). Log in with admin / admin and use the following commands to assign NetCam a temporary IP address. Once the IP has been assigned, browse to NetCam with a web browser and configure NetCam to have a permanent static IP address.

In the following example, NetCam is being assigned a temporary IP address of 192.168.0.2 via a terminal program connected to the S1 port on the back of NetCam:

```
ifconfig eth0 192.168.0.2
route add -net 192.168.0.0 netmask 255.255.255.0 eth0
```

Remember, once you can reach NetCam via its temporary IP address, you'll want to immediately assign it a permanent static IP address in the network configuration menu.

1.6 Connecting NetCam to a Modem

In order to use NetCam with an analog phone line, you will need the Dial-Out NetCam package (CAM-NETx2, which comes with an external modem and cable), a dial-up ISP account, and an analog phone line.

- 1 Install the StarDot Tools software by inserting the included CD-ROM and running `setup.exe`.
- 2 Connect one end of the null model serial cable to the **S1** port of NetCam and the other end into an available serial port on your PC.
- 3 Connect the round end of the modem cable into the external modem and plug the modem power supply into the modem (modem and modem cable both included with remote package).
- 4 Plug the DB9 end of the modem cable into the **S0** port of NetCam.
- 5 Run the StarDot Tools software and click on the Setup Wizard button.
- 6 Follow the steps in the Setup Wizard. When asked for modem type, select 3JTech.
- 7 **Test your configuration locally first.** Once successful, you can place NetCam and the modem remotely and it will automatically dial out to the Internet and upload images according to the set schedule.

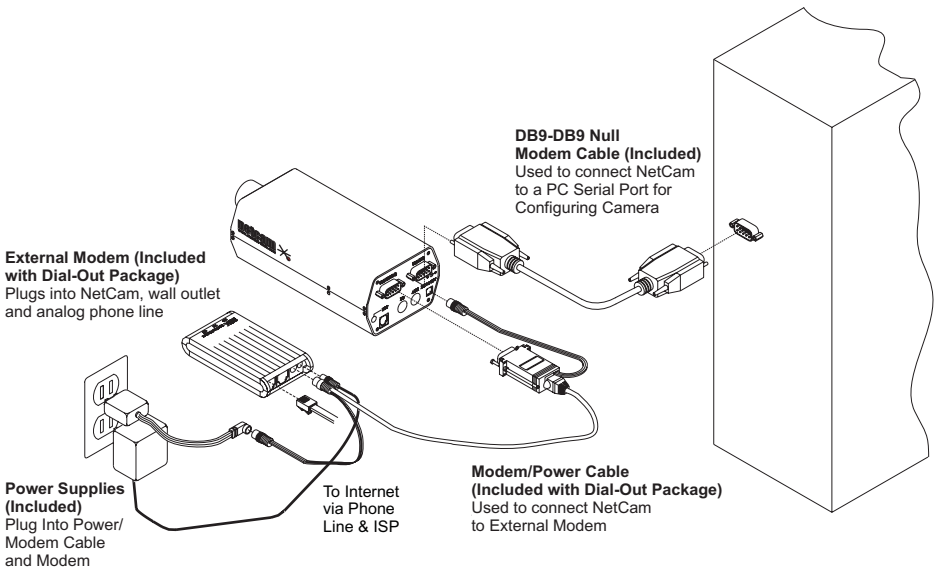

Chapter 2 Installation

Before installing NetCam in its final location, it is important to configure and test it first (see Chapter 1).

2.1 Installing NetCam

Ethernet Connection

If NetCam will be connected directly to an Ethernet network, measure the distance from NetCam to the nearest Ethernet hub or switch. This distance should not exceed 300 feet. If you wish to extend the distance further than 300 feet, you can add an Ethernet hub or switch.

Running Separate Ethernet and Power

Run standard CAT 5 or better Ethernet cable from the hub/switch to the **NET** jack on the back of NetCam. Plug the included power supply into the back of NetCam.

Running Combined Ethernet and Power

To save the hassle of running both power and network cables (or having to have a 110V power supply at the camera location), NetCam ships with a 50 ft. combo Ethernet/power cable. You can use this in place of standard CAT 5 network cable. Plug the included power supply into the power tail jack on one side of the cable and plug the network plug into a hub. The other end of the cable plugs into the NetCam's **PWR** and **NET** jacks (see illustration in Chapter 1.4).

If you need a longer cable, StarDot offers lengths of 100, 200 and 300 feet. Keep in mind that the longer combo cable lengths require a power supply with higher voltage output (voltage drops over the length of a cable). The appropriate power supply is included with the longer combo cables.

Modem Connection

If NetCam's connection to the Internet will be a dial-out ISP connection, an external modem and modem cable are required (these are provided with the Dial-Out NetCam package).

Connect the external modem's power supply into an AC wall outlet. Connect the external modem into a phone jack using a standard telephone cable. Using the included DB9 Female to round connector cable, connect the external modem into the **S0** port on the back of NetCam.

It is important that NetCam be pre-configured for a dial-out modem connection before placing the camera in its final installation location (see Chapter 1.6).

2.2 Installing NetCam Outdoors

NetCam is an outdoor-capable camera, but two important steps must be taken before NetCam can be used in an outdoor environment. NetCam's lens must be adjusted for daylight imaging, and NetCam must be enclosed in an outdoor enclosure.

Lens Adjustment

NetCam ships with a manual iris lens (if you ordered a different lens with NetCam, it will most likely have a manual iris). **The iris must be closed down to a pinhole size before using the camera in daylight lighting.** If the lens has markings on the iris ring, you will want to close the iris down to $f/16$ or larger (the larger the f -stop, the smaller the iris). If the lens does not have numerical markings on the iris ring (it may just show "open" and "close" with arrows), look into the lens and turn the iris until the hole is about the size of a pinhole.

The pinhole size is an approximation. To precisely set the iris, add \$e to the image overlay (the text printed on the image). This will print the current exposure. During daylight, this value should fall between 100 and 500. You generally do not want to see the exposure with a value below 100. If your exposure is reading below 100, adjust the iris smaller until it reads between 100 and 500. Note: Make sure Auto Exposure is enabled.

Failure to set the iris properly in daylight lighting may result in streaky image quality and will prematurely cause permanent damage to the CCD sensor. NetCam's auto exposure logic will automatically compensate for changes in brightness throughout the day by adjusting the exposure. NetCam can take great quality images from dawn to dusk with a manual iris lens, provided it's set properly. For more information on daylight imaging and how to achieve the best quality possible, see Chapter 4.1.

Mounting the Camera

To mount NetCam outdoors, it must first be encased in an outdoor enclosure (different models are available from StarDot Technologies, see <http://www.stardot-tech.com/netcam>).

Install NetCam in an outdoor enclosure and adjust the internal mount so NetCam's lens is up against the enclosure window. This helps to reduce glare.

Determine where NetCam will be pointing and where you'd like to mount it. The outdoor enclosures can be mounted on a horizontal or vertical surface. When aiming the camera, factors such as sun travel and amount of visible sky can vastly affect the quality of the image. For imaging tips, see Chapter 4.1.

Chapter 3 Accessing NetCam

3.1 Viewing NetCam's Images

Any Java-enabled browser can be used to view the live images. Type NetCam's IP address in your browser's address bar (example: `http://192.168.1.5`).

3.2 Accessing NetCam's Configuration Menus

Virtually any web browser can be used to access NetCam's configuration menus. To access these menus, type NetCam's IP address in your browser's address bar (example: `http://192.168.1.5`). This will bring up the live image page. Click on the Configuration link. You will be prompted for a User Name and Password. Use `admin` for both.

Tip: *We highly recommend that you change the default password. To do so, see Chapter 3.8.*

3.3 Image Properties

All image-related configuration options are located on the Image Properties page. After making changes, click the Apply button to save new settings in the camera.

The screenshot shows the 'Image Properties' configuration window. At the top, there are tabs for 'Image', 'Overlay', 'FTP', 'Applet', 'Date/Time', 'Network', 'Dial-Out', and 'Security'. The 'Image' tab is selected. The 'EXPOSURE' section has radio buttons for 'Manual' and 'Auto' (selected). It includes input fields for 'Exposure: 500', 'Brightness: 60', 'Sensitivity: 20', 'Min: 0', and 'Max: 12500'. There are also radio buttons for 'Fluorescent Sync' set to 'Off'. The 'EXPOSURE GRID' is a 5x5 grid of checkboxes, with the middle three columns checked. A 'View Grid' button is below it. The 'PROCESSING' section includes a 'Resolution' dropdown set to 'Color: 640 x 480', 'Saturation: 1250', 'Gamma: 1700', 'Intensity: 1024', 'Haze: 25', 'JPEG Quality: 70', and a checked 'Sharpen' checkbox. 'Color Balance' is set to 'Auto'. 'Initial (manual)' values are R: 1890, G: 1024, B: 2940. 'Skew (auto)' values are R: 1024, G: 1024, B: 1024. A note states '(1024 means "no change")'. At the bottom right are 'Help', 'Apply', and 'Cancel' buttons.

EXPOSURE

Auto vs. Manual

Unless you have a controlled (fixed) lighting condition, you will almost always want to leave Auto Exposure enabled.

Auto Exposure

Enabling Auto Exposure causes NetCam to automatically adjust the image exposure based on the overall brightness of the image. The following functions are only implemented when Auto Exposure is enabled.

- **Brightness** - The higher the number, the brighter the picture. The default value is 60.
- **Sensitivity** - This value rarely needs to be adjusted. It sets the sensitivity of the Auto Exposure code. A higher number means a bigger change in lighting is required for the auto exposure to adjust. The default value is 20.
- **Min & Max** - Min is the minimum exposure NetCam will expose images at (default is 0). The default value is the recommended value. Max is the maximum exposure NetCam will expose images at (default is 12500, 1/5 second). If your image looks noisy during low light conditions, you can decrease the max exposure value.

Fluorescent Sync

If NetCam is imaging in an area lit by fluorescent lighting, enabling the appropriate frequency (60Hz for US) will prevent NetCam from producing a change in brightness or color balance that often accompanies imaging under fluorescent lights. For outdoor shots (any other non fluorescent lighting condition), set to off. The default value is off.

Manual Exposure

Enabling Manual Exposure causes NetCam to expose images at the value placed in the Exposure field. Keep in mind that using manual exposure is not advised for outdoor imaging, since the light conditions are constantly changing. You may opt to use manual exposure indoors if your lighting conditions do not change. Here are some sample values and their fractional equivalents:

50	=	1/1000 second
500	=	1/100 second
833	=	1/60 second
1667	=	1/30 second
3333	=	1/15 second
6250	=	1/8 second (may introduce CCD pixel noise)
12500	=	1/4 second (may introduce CCD pixel noise)

Exposure Grid

When Auto Exposure is enabled, NetCam adjusts the exposure of the image based on the average brightness of the pixels located in the selected regions in the Exposure Grid. If you want NetCam to determine the exposure based on only the sky, you would select the squares that apply to the sky

(click the View Grid button to see the grid over the image). Conversely, if you'd like the exposure to be determined by the foreground, select only those squares. This is comparable to the spot exposure on a traditional camera. The default is the center 9 squares.

PROCESSING

Resolution

Resolution is the dimensional size of the NetCam image, measured in pixels, horizontal by vertical. The maximum resolution of NetCam is 640x480 (1280x960 on NetCam MP) and the minimum is 96x80 color (80x60 grayscale). The higher the resolution, the larger the picture appears in your browser, and the longer it takes to download (and the longer it takes for NetCam to process and create).

Default: 320x240 (640x480 on NetCam MP)

Tip: *As with most digital cameras, NetCam achieves the highest quality and clearest images at quarter resolution. This is due to the way color is calculated with digital image sensors. The highest quality image on NetCam is 320x240. On NetCam MP, the highest quality image is 640x480.*

Saturation

This represents the amount of color in the image. The higher the number, the more saturated the color.

Default: 1200

Gamma

Gamma correction is a post-processing enhancement that increases the detail in shadowy areas of the image. The higher the value, the lighter the shadows, at the expense of increased haziness.

Default: 1700

Intensity

Intensity is a post-processing enhancement that increases the brightness of the image. This should not be confused with the brightness under the auto exposure settings, which is a preprocessing setting. Intensity artificially brightens the image after it's already been exposed and color processed. In most applications, the default of 1024 (no intensity change) is recommended. If you have a dark lighting situation, you can experiment by increasing this value. For example, 2048 doubles the brightness. You will most likely need to adjust the Auto Exposure Brightness to counter balance the effect (to prevent images that appear overexposed).

Default: 1024

Haze

Haze is a factory setting and should normally not be changed.

Default: 10

JPEG Quality

The JPEG Quality is a balance between lossy image compression and image quality. The higher the number, the less compression artifacts in the image, but the bigger the file size. **A value higher than 90 is not recommended, as it greatly increases the file size with very little noticeable difference in image quality.**

Default: 70

Sharpen

When enabled, a software sharpening is performed on the live image. For the best image quality, sharpen should be on.

Default: On

Auto Color Balance

Enabling Auto Color Balance causes NetCam to automatically adjust the color balance of the image, based on the content of the image. In most situations, you will want Auto Color Balance enabled. You can skew the red, green and blue values if needed.

Default: On

Manual Color Balance

Enabling Manual Color Balance causes NetCam to use the manual Red, Green and Blue values to set the color balance of the image. You may want use manual color balance if you have a fixed lighting situation.

R - This represents the amount of red in the image.

G - This represents the amount of green in the image.

B - This represents the amount of blue in the image.

Note: As a starting point for setting manual color balance values, enable Auto Color Balance and place the current R, G, B values in the image overlay.

Sample string: Red: \$r Green: \$g Blue: \$b

Once you see the current values of the image, you can place those in the R, G, B settings and have a manually balanced image.

3.4 Overlay Properties

The Overlay Properties allow you to edit the text displayed on the image. After making changes, click the Apply button to save the settings in the camera.

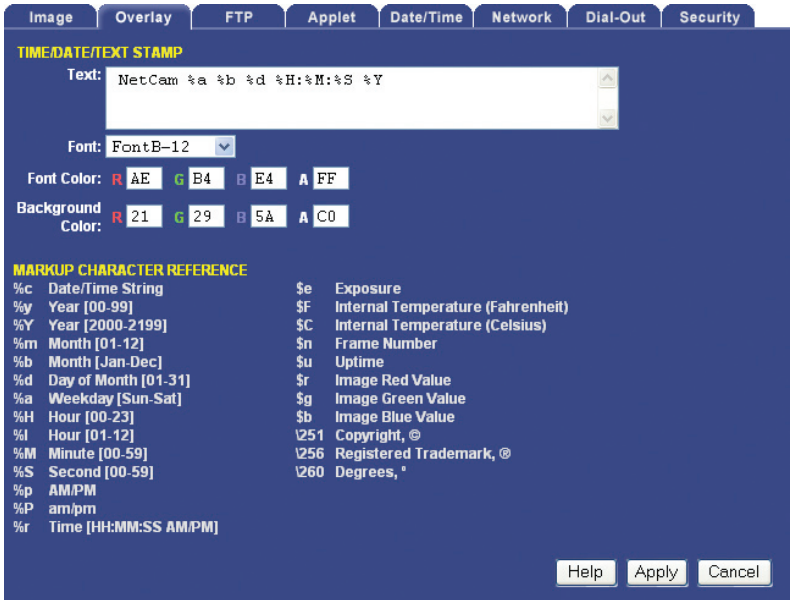

TIME/DATE/TEXT STAMP

Text

Any text entered into this field will be stamped onto the live image. Camera location and copyright information are two examples. In addition to static text, the current date and time, as well as internal camera parameters, can all become part of the text on the live image. This is handled through markup characters. For instance, %d inserts the current day of the month on the live image. There is a complete list of markup characters below and a mini reference on the Overlay page itself.

Default: NetCam %a %b %d %H:%M:%S %Y

Font

Five different font styles/sizes are available for the overlay text:

FontA-24	24-Point Sans-Serif Block Condensed
FontA-24-s	24-Point Sans-Serif Block Condensed, Anti-Aliased
FontB-12	12-Point Sans-Serif
FontB-12-s	12-Point Sans-Serif, Anti-Aliased
Mono-8	8-Point Mono Font

Default: FontB-12

Font Color

The text color can be modified by adjusting the red, green and blue values. In addition, you can change the alpha level or transparency of the text. Valid ranges are in hexadecimal and range from 00-FF.

Default: R: AE G: B4 B: E4 A: FF

Background Color

The text background color can be modified by adjusting the red, green and blue values. In addition, you can change the alpha level or transparency of the text background. Valid ranges are in hexadecimal and range from 00-FF.

Default: R: 21 G: 29 B: 5A A: C0

Sample Colors Chart

<u>R</u>	<u>G</u>	<u>B</u>	
FF	00	00	Red
00	FF	00	Green
00	00	FF	Blue
FF	FF	00	Yellow
00	FF	FF	Cyan
FF	00	FF	Purple
FF	FF	FF	White
7F	7F	7F	Gray
00	00	00	Black

Markup Character Reference

All of the following markup characters can be used in the text overlay. Additionally, any date/time markups (preceded by the % character) can be used to compose the filenames in the FTP Properties Page, which is very useful for archiving images with unique filenames (based on the current date and time, for instance).

Date Markups

%Y	Year, Four-Digit [2000-2199]
%y	Year, Two-Digit [00-99]
%m	Month, Numerical [01-12]
%B	Month, Full [January-December]
%b	Month, Abbreviated [Jan-Dec]

%U	Week of Year (Starting with Sunday) [00-53]
%W	Week of Year (Starting with Monday) [00-53]
%d	Day of Month [01-31]
%w	Day of Week, Numerical (Sunday=0) [0-6]
%u	Day of Week, Numerical (Monday=1) [1-7]
%A	Day of Week, Full [Sunday-Saturday]
%a	Day of Week, Abbreviated [Sun-Sat]
%j	Day of Year (Julian Day) [001-366]
%p	AM/PM, Uppercase
\$(Z)	Timezone

Time Markups

%H	Hour, Military [00-23]
%I	Hour, Standard [00-12]
%M	Minute [00-59]
%S	Second [00-59]
\$(O3 [Milliseconds [000-999]
\$(O3]	Microseconds [000-999]

Date & Time Shortcut Markups

%D	Date String [mm/dd/yy]
%r	Time String [HH:MM:SS AM/PM]
%T	Time String, Military [HH:MM:SS]

Symbol Markups

\260	Degree Sign, °
\251	Copyright Sign, ©
\256	Registered Sign, ®
\261	Plus-Minus Sign, ±
%%	Percentage Character, %

Camera Markups

\$(e	Camera Exposure
\$(IF)	Internal Camera Temperature, in Fahrenheit
\$(IC)	Internal Camera Temperature, in Celsius

\$n	Frame Number
\$u	Camera Uptime
\$r	Amount of Red in Image, Hexadecimal
\$g	Amount of Green in Image, Hexadecimal
\$b	Amount of Blue in Image, Hexadecimal
\$I	Image Intensity
\$z	Image Haze
\$W	Image Width
\$H	Image Height
\$M	MAC Address (Camera ID)
\$E	Ethernet IP Address
\$P	PPP IP Address (ISP Dial-Out IP)

NetCam supports much of the ISO 8859-1 character set, which is very useful for adding foreign language text to NetCam's overlay. For a list of characters, visit stardot-tech.com/netcam/netcam-overlay.txt

Positioning Markups

All positioning markups that begin with \033 must be at the beginning of a line.

\033l	Position Text on Left
\033h	Center Text Horizontally
\033r	Position Text on Right
\033t	Position Text on Top
\033v	Center Text Vertically
\033b	Position Text on Bottom
\033t\033l	Position Text in Top Left, This is the default even if you don't use the markup.
\033t\033r	Position Text in Top Right
\033b\033l	Position Text in Bottom Left
\033b\033r	Position Text in Bottom Right
\033h\033v	Position Text in Center

3.5 FTP Properties

The FTP Properties instruct NetCam to upload images to a remote server. After making changes, click the Apply button to save the settings in the camera.

Image Overlay **FTP** Applet Date/Time Network Dial-Out Security

FTP UPLOAD

Hostname:

Username: Password:

Path/File:

Rotating Archive (last 10 images)

Passive Mode Timeout: seconds

Delete Before Rename IIS 4.0

Secondary Path/File:

Current IP Link Path/File:

SCHEDULE

Delay seconds between uploads

Upload between and (Military Format - HH:MM)

Sun Mon Tue Wed Thu Fri Sat

Help Apply Cancel

FTP Upload

FTP stands for File Transfer Protocol, one of the most popular methods for transferring files over the Internet. In addition to NetCam serving images from its internal web server, NetCam can also upload images to an external web server. This is useful if you plan on having a large number of visitors viewing the live images or if you'd like to archive every image NetCam takes. To enable image uploads, check FTP Upload on and fill out the options below.

Required Fields

Hostname

The hostname is the name of the server where you'd like NetCam to upload images to. It can be a machine name or IP address. Do not include the `http://` or `ftp://` header or a path.

Example: `myserver.com` or `ftp.myserver.com`

Username

This is the username or login name assigned to you by your hosting company.

Password

This is the password assigned to you by your hosting company.

Path/File

This field combines two elements, the image filename, preceded by an optional path or directory. Consult with your hosting company to determine if you need to specify a path. If you don't, you simply put the desired name of the image file here.

Example Without Path: netcam.jpg

Example With Path: /html/images/netcam.jpg

Advanced Fields

Rotating Archive

If enabled, NetCam will use a renaming scheme to store the current 10 images on your server. A hyphen, followed by the archive number (0-9) is automatically appended to the end of the filenames.

Default: Off

Passive Mode

If NetCam is behind a proxy server, enable passive mode. If you are unsure if you need passive mode, it is usually safe to enable it anyway.

Default: On

Timeout

If the FTP transfer is unsuccessful, Netcam will abort and re-initiate the process after the specified amount of seconds.

Default: 120

Delete Before Rename

NetCam employs a file renaming scheme, which greatly reduces the possibility of file collisions between NetCam uploading an image and viewers downloading the image. The image is uploaded with a .tmp extension. Once uploaded the tmp file is renamed without the .tmp extension. Certain FTP/Web servers do not allow a file to be renamed to a filename that already exists. To get around this problem, enable Delete Before Rename.

Default: Off

IIS 4.0

Some FTP servers lock a file when a file with the same filename is constantly uploaded and renamed. If you have problems seeing your image update on your web site, try enabling the IIS 4.0 option. This option is only valid if Delete Before Rename (above) is also enabled.

Default: Off

Secondary Path/File

NetCam can optionally upload the image with a separate path and/or filename from the Path/File above. This provides a very convenient way to archive images on your server while still maintaining a statically named live image. One way to do this is to include date/time markup characters as part of the filename. The current upload time of the image will become the filename.

For example, the filename `%Y-%m%d-%H%M%S.jpg` automatically translates to `2006-04-15-153015.jpg` if the date and time of the upload is April 15, 2006 at 3:30:15 PM.

Tip: *For a complete list of Date/Time markup characters, click the Help button on the Overlay page.*

Example Without Path:

```
netcam-%Y-%m%d-%H%M%S.jpg
```

Example With Path:

```
public_html/netcam-%Y-%m%d-%H%M%S.jpg
```

Only the characters beginning with the percentage symbol (%) are valid. It not advisable to use date/time characters that insert / \ : or space characters, as this can confuse the FTP/Web server.

Current IP Link Path/File

If NetCam is using an external modem to dial out to an ISP, NetCam will most likely be assigned a different IP address every time it connects. This makes it next to impossible to access the camera directly from a browser since its IP address is not known. To eliminate this problem, NetCam can upload a small web page every time an image is uploaded. The web page contains the current IP address of the camera so you can configure the camera remotely. Clear this field if you don't want this file to be uploaded.

Default: `ip.html`

Schedule

Scheduling tells NetCam when and how often to FTP images to your server.

Delay

This tells NetCam to delay a specified number of seconds between FTP image uploads. The speed at which NetCam can upload varies on the image resolution, amount of JPEG compression, Internet connection and network congestion.

Keep in mind that the overhead of FTP doesn't allow for the same update rates that you see when accessing NetCam directly with a browser. It is safe to say that FTP restricts 320x240 uploads to once every 3-6 seconds, even on a DSL or cable connection. 640x480 images will probably not upload faster than once every 10-15 seconds.

Default: 30

Upload Window

NetCam can upload images 24 hours a day, seven days a week, or you can set whatever time window and days of the week you like. Use military time for the beginning and ending window times.

Example: You can configure NetCam to only upload Between 07:30 and 18:30 only on Mon, Tue, Wed, Thu and Fri

How do I display the live image on my web site?

The simplest way to add the live image on one of your web pages is with the image tag: ``

To see the current live image, the visitor would have to hit the refresh button. This reloads the web page and will display the current live image, assuming a new image has uploaded already.

You can add a meta tag to the `<head>` section of your web page that tells the browser to refresh the web page at specified interval: `<meta http-equiv="refresh" content="30">`

If you prefer a slicker solution that doesn't require refreshing the whole page and visibly redrawing the live image, StarDot provides a free Java applet. You can download the Capture Client Java applet and instructions here:

www.stardot-tech.com/netcam/downloads.html

3.6 Applet Properties

The Applet/Web Properties page contains information for customizing the NetCam image-viewing Java applet. After making changes, click the Apply button to save the settings in the camera.

The screenshot shows the 'Applet' tab of the NetCam configuration interface. The title is 'VIEWER JAVA APPLET'. The 'Size' section has three radio buttons: 50%, 100% (selected), and 200%. The 'Delay' is set to 500 ms, with a note '(1000 ms = 1 second)'. The 'Image-Click URL' is an empty text field. The 'Status Bar' is a dropdown menu set to 'Browser Window'. The 'Status Text' is a text field containing 'Reload in %s seconds'. The 'Status Text Color' is a hex code field with 'ffffff'. The 'Status Bar Color' is a hex code field with '000000'. At the bottom right are 'Help', 'Apply', and 'Cancel' buttons.

IMAGE VIEWER JAVA APPLET

The live images on the main NetCam web page are presented with the aid of a Java applet called Capture Client. This allows for smooth transitions between image frames. Options include the ability to add a countdown status bar and the ability to change the click URL.

Size

If the NetCam image is 320x240 and the size is 100%, the applet will display the image at its original size, in this case 320x240. If the size is 50%, the image will display at half size, in this case 160x120. If the size is 200%, the image display at double size, in this case 640x480. Keep in mind that the JPEG image is still the size specified in the Image Properties page; the applet resize option simply reduces or stretches the original image. In most cases, you would leave it at 100% (no resize).

Default: 100%

Delay

The Java applet will delay for this amount of time before attempting to fetch another live image. The time is measured in milliseconds (1000 ms = 1 second).

Image-Click URL

When a viewer clicks on the live image, their browser will go to the URL (web address) contained here.

Status Bar

The applet contains an optional status bar displayed in the browser status bar or at the bottom of the applet.

Status Text

This is the text that is displayed in the applet status bar (if enabled).

Default String: Reload in %s seconds

Status Text Color

This is the color of the text that is displayed in the applet status bar (if applet status bar is enabled). The color is defined in the HTML standard of 3 numbers for RGB. Format: RRGGBB (RR=red, GG=green, BB=blue, all values hexadecimal 00-FF).

Default: *ffffff*

Status Bar Color

This is the color of the background that is displayed in the applet status bar (if applet status bar is enabled). The color is defined in the HTML standard of 3 numbers for RGB. Format: RRGGBB (RR=red, GG=green, BB=green, all values hexadecimal 00-FF).

Default: 000000

3.7 Date/Time Properties

The Date/Time Properties allow you to set the date and time in NetCam. After making changes, click the Apply button to save the settings in the camera.

The screenshot shows the 'Date/Time' configuration window. The 'AUTOMATIC' option is selected. The 'Time Server' is set to 'time.nist.gov'. The 'MANUAL' option is unselected. The 'Date/Time' field shows 'Wed Mar 8 14:38:49 2006' and a 'Sync' button. The 'TIME ZONE' dropdown is set to 'PST8PDT'. A list of time zones is provided below the dropdown. The 'Apply' button is highlighted.

Setting the Date and Time

Automatic vs. Manual - For the most accurate date & time, having NetCam automatically synchronize with a network time server is recommended.

Automatic Time Set

When Automatic time synchronization is enabled, NetCam will query a network time server and synchronize the camera's date and time, usually accurate to within seconds or less. This will happen every time the camera is powered on or rebooted, provided NetCam is connected to the Internet or a network with a time server.

- **Time Server** - The name (or IP address) of a time server is entered here. Some popular ones include:

```
time.nist.gov
tock.usno.navy.mil
ns.arc.nasa.gov
```

Note: While these time servers have proved reliable over the years, there is no guarantee that they will always be available to the public.

Manual Time Set

If you don't have access to a time server, you may opt to manually set NetCam's clock. You can do this in one of two ways. Using the Sync button, you can synchronize NetCam's clock to your PC's clock. You may

also manually modify the time and date in the Date/Time box. In either case, be sure to hit the Apply button after you've set the time.

Note: When using Internet Explorer, the Date/Time page may disappear after clicking the Apply button. If this happens, click the refresh button twice.

TIME ZONE

NetCam integrates your current time zone into the time/date string and can even automatically adjust for daylight savings time. Type in the time zone code from the list on this page. If your time zone is not listed, enter your abbreviated time zone followed by the number of hours you are behind GMT (if you're ahead of GMT, add the "-" character before the value).

HST10	Hawaiian Standard Time
AT10ADT	Aleutian Standard/Daylight Time (Alaska, parts)
YST9YDT	Yukon Standard/Daylight Time (Alaska, parts)
PST8PDT	Pacific Standard/Daylight Time
MST7MDT	Mountain Standard/Daylight Time
MST7	Mountain Standard Time (Arizona)
CST6CDT	Central Standard/Daylight Time
EST5EDT	Eastern Standard/Daylight Time
AST4ADT	Atlantic Standard/Daylight Time
NST3:30NDT	Newfoundland Standard/Daylight Time
WET0WETDST	Western European Standard/Daylight Time
PWT0PST	Portuguese Winter/Summer Time
MEZ-1MESZ	Mitteleuropaeische Zeit/Sommerzeit
MET-2METDST	Middle European Standard/Daylight Time
SAST-2SADT	South African Standard/Daylight Time
JST-9	Japan Standard Time
WST-8:00	Australian Western Standard Time
CST-9:30	Australian Central Standard Time
CST-9:30CDT	Australian Central Standard/Daylight Time
EST-10	Australian Eastern Standard Time
EST-10EDT	Australian Eastern Standard/Daylight Time
NZST-12NZDT	New Zealand Standard/Daylight Time

3.8 Network Properties

The Network Properties page contains all the IP configuration information for setting up NetCam on a network. After making changes, click the Apply button to save the settings in the camera.

Image Overlay FTP Applet Date/Time **Network** Dial-Out Security

ETHERNET

IP Assignment: DHCP Manual

IP Address: 192.168.2.85

Subnet Mask: 255.255.0.0

MAC Address: 00:30:f4:c4:06:5a

NETWORK

Hostname: netcam

Gateway: 192.168.0.1

NAME SERVERS

DNS 1: 65.60.123.67

DNS 2: 64.60.0.17

DNS 3: 64.60.0.18

WEB SERVER

Port: 80 (Default=80)

Help Apply Cancel

Ethernet

If your network is Ethernet-based (LAN, cable modem, DSL), use the **NET** port on the back of NetCam to access the camera. The first step to network access is assigning NetCam an IP address. There are two ways in which this can be done: automatically (DHCP) or manually.

IP Assignment

DHCP

By default, NetCam comes up in DHCP mode, meaning that it probes the network for a DHCP server. If there is a DHCP server on the network, NetCam is automatically assigned an IP address, subnet mask, gateway, and name servers. No manual configuration is needed. One negative of DHCP mode is not knowing which IP address NetCam was given. Use the StarDot Tools software to find DHCP-assigned NetCams on your local network.

Manual

If you'd like to manually assign NetCam an IP address, set NetCam to Manual IP Assignment and provide the following information:

- **IP Address** - The IP address you'd like to assign the camera. Consult your network administrator to determine which IP address

to use. If you are setting up NetCam behind a residential gateway or cable/DSL router, your IP address will probably be something similar to 192.168.1.5.

- **Subnet Mask** - Find out your netmask from your network administrator. If you're on a private network, your netmask will almost always be 255.255.255.0.
- **MAC Address** - This is the factory-set Ethernet address of the camera. It also serves as the Camera ID (serial number). It cannot be changed.

Network

Hostname

Alphanumeric name of NetCam that can get linked to NetCam's IP address. This is disabled if DHCP is enabled.

Default: netcam

Gateway

In most cases, this is a machine name or IP address that serves as a gateway to the Internet. If NetCam is on a private network behind a router/gateway, you would enter the IP address of the router/gateway. This is disabled if DHCP is enabled.

Domain Name Servers (DNS)

Domain name server IP address. This is critical if your FTP server and/or time server is entered as a domain name and not an IP address. Check with your ISP to determine your name servers (you can list up to three). This is disabled if DHCP is enabled.

Web Server Port

In most situations you will want to leave the web server port at its default value of 80. The only situation that calls for changing the port number is if you're hosting one or more NetCams behind a residential router/gateway that supports port forwarding. This allows you to access multiple NetCams behind a single public IP address.

Example: Assign NetCam a web server port of 8085. In your router, under the port forwarding section, route port 8085 to NetCam's IP address.

Use caution when changing the web server port number. If it's anything but 80, you will need to add `<:port number>` to the end of the IP address (Example: `http://192.168.1.5:8085` from the local network or `http://208.146.196.41:8085` on the Internet) when browsing to NetCam.

Default: 80

3.9 Dial-Out Properties

The Dial-Out Properties page contains all the ISP dial-up configuration information for setting up NetCam on a dial-up modem. After making changes, click the Apply button to save the settings in the camera.

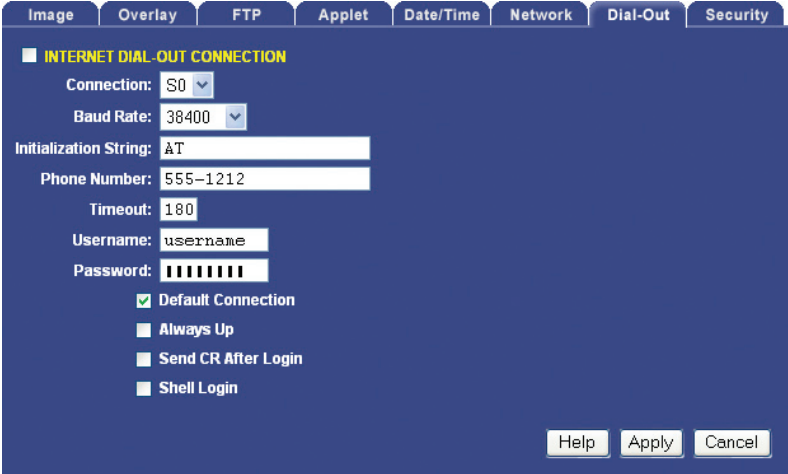

The screenshot shows the 'Dial-Out' tab of the NetCam configuration interface. The title is 'INTERNET DIAL-OUT CONNECTION'. The settings are as follows:

- Connection: S0 (dropdown)
- Baud Rate: 38400 (dropdown)
- Initialization String: AT (text field)
- Phone Number: 555-1212 (text field)
- Timeout: 180 (text field)
- Username: username (text field)
- Password: [masked with 8 dots] (password field)
- Default Connection
- Always Up
- Send CR After Login
- Shell Login

Buttons at the bottom right: Help, Apply, Cancel.

Internet Dial-Out Connection (PPP)

If NetCam's primary connection to the Internet will be a dial-up modem connection to the Internet, enter your ISP (Internet Service Provider) account information here.

Check this option on if you'd like NetCam to use an external modem to dial the Internet.

Baud Rate

This represents the speed or baud rate at which NetCam will communicate with the external modem. For most dial-up accounts, a baud rate of 38400 or 19200 works best.

Default: 38400

Initialization String

This is a string that configures your modem before dialing the Internet. The default string works fine in most cases.

Default: AT

Phone Number

The phone number of the ISP (Internet Service Provider). You can embed special characters in the phone number.

, = pause one second

= same as # button on phone

* = same as * button on phone

Timeout

NetCam will attempt to dial up the ISP for the specified number of seconds. If NetCam is unable to connect during this time period, it will stop and start over again.

Default: 180

Username

The username or login assigned to you by your ISP.

Password

The password assigned to you by your ISP.

Default Connection

Enabling this option makes the ISP dial-out connection NetCam's default connection to the Internet.

Default: On

Always Up

If enabled, NetCam will attempt to stay continuously connected to the Internet. If disconnected, it will automatically attempt to reconnect. If NetCam is configured to upload images to a server via FTP, it is not necessary to enable this option; NetCam will automatically attempt to dial into the Internet when an image is scheduled to upload if dial-out is enabled. If your NetCam is set to FTP images, it is recommended that you do not enable this option but rather let the FTP upload schedule keep the camera online.

Default: Off

Send CR After Login

This advanced ISP option tells NetCam to send a CR (Carriage Return) after logging in. Most ISP's do not require this.

Default: Off

Shell Login

This advanced ISP option tells NetCam to perform a shell login. Most ISP's do not require this.

Default: Off

3.10 Security Properties

The Security properties page contains user/password information for securing NetCam from unwanted visitors.

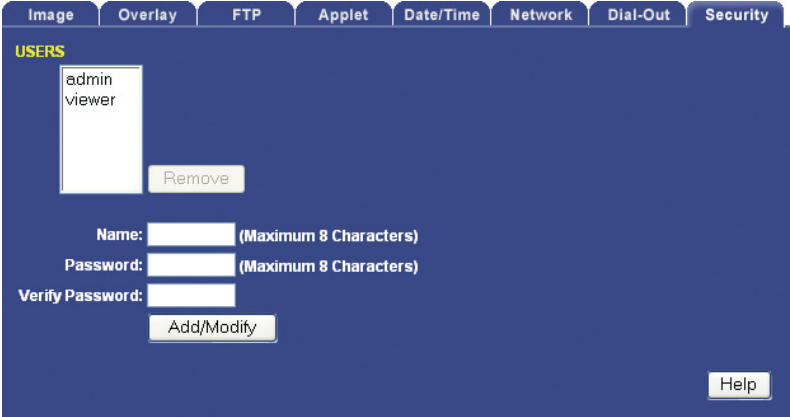

The screenshot shows the 'Security' tab of the NetCam configuration interface. The 'USERS' section contains a list of users: 'admin' and 'viewer'. Below the list is a 'Remove' button. There are three input fields for 'Name:', 'Password:', and 'Verify Password:', each with a '(Maximum 8 Characters)' label. An 'Add/Modify' button is located below the password fields. A 'Help' button is in the bottom right corner.

NetCam Users

NetCam has its own multi-user capable, password protected operating system. By default, the live images can be viewed by anyone and only the configuration pages are password protected. However, these options can be changed.

admin - The *admin* user has configuration and viewing rights. It is strongly recommended that you change the default password (initially “admin”) to something else. This will prevent anonymous users from logging into the camera and making changes. It is important to choose your password carefully. Pick something that cannot be easily guessed. The password can be a combination of alpha and numeric characters, upper and lowercase (maximum 8 characters).

Tip: Use a password that cannot be easily guessed (maximum 8 characters).

viewer - The *viewer* user only has viewing rights (this user cannot access the configuration menus). By default, the *viewer* user has no password. This allows anyone to view the images on the camera without being prompted for a password. If you want to block public access to the live image, you will need to change the password for the *viewer* user.

To modify the password of an existing user, click on the user name and then type in a new password in the password field (retype it in the verify password field). Then click the Add/Modify button.

Adding a New User

To add a user to the Users list, type in the desired username in the Name field. Type and retype a password in the Password fields. Click the Add/Modify button. New users will only have viewing rights; only the *admin* user can make configuration changes in the camera.

Deleting a User

To remove a user from the Users list, click on the desired username and click on the Remove button. Note: The default users, *admin* and *viewer*, cannot be removed.

3.11 Advanced Menu

The advanced menu is a hidden menu that allows you to configure some advanced features inside NetCam such as the Weather Station and Dynamic DNS support.

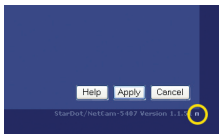

In order to access the advanced menu you will need to click the small linked character to the right of the version number, under the Help, Apply and Cancel buttons.

Note: The advanced menu provides access to all of the configuration files in NetCam. We recommend that you do not edit these files unless you are well versed in Linux and NetCam camera settings.



On the upper left of the advanced menu are option are links to options such as the optional weather station and dynamic DNS support.

TZO Dynamic DNS



If NetCam is behind a DSL or cable modem connection and the public IP address changes, you can use tzo.com as a dynamic DNS service. This maps your dynamic (i.e. always changing) IP address to a static hostname of your choice (i.e. yourcompany.stardotcams.com or yourname.remotecam.com).

Why is knowing your public IP address valuable? If your router is configured to “port forward” port 80 to NetCam’s local IP address, you can browse to NetCam directly from anywhere on the Internet. This is useful for viewing the camera live and making configuration changes from a remote location. For information on configuring port forwarding on a router, visit www.portforward.com.

To set up a TZO account, visit <http://stardot.tzo.com>. After you’ve signed up, enter the appropriate information in either NetCam or your router (if it supports DDNS).

Weather Station



StarDot offers an optional mini weather station (AUX-WX2) that plugs into the back of NetCam. It’s a great way to capture and display the current temperature, humidity and barometric pressure. To view the weather data, add one or more of the markup tags in your overlay text:

<code>#{C}</code>	Degrees in Celsius
<code>#{F}</code>	Degrees in Fahrenheit
<code>#{HUM}</code>	Humidity Percentage
<code>#{MB}</code>	Millibars
<code>#{HGIN}</code>	Inches of Mercury
<code>#{HGMM}</code>	Millimeters of Mercury

Example: `#{F} °F #{HUM}%% #{HGIN} in.`

Chapter 4 *Imaging Tips*

As is the case with any camera, whether digital or film-based, steps can be taken that will greatly improve image quality. NetCam is no exception to this rule. The following tips will help you achieve the best possible images with NetCam.

4.1 Lighting

Lighting is the single most important factor in quality photography. Proper lighting makes the difference between an amateur-looking snapshot and a professional-looking image. Lighting for a live still camera such as NetCam can be divided into two categories: outdoor and indoor.

Outdoor Lighting

In most outdoor imaging situations, you do not have much control over the lighting since most of your lighting obviously comes from the sun. However, you do have control over the lens settings and the positioning of NetCam. If you have a motorized zoom lens, you can ignore the iris section, since the iris is controlled automatically by NetCam.

The Iris

The first thing to consider with outdoor lighting is the lens iris. The iris is an adjustable ring that controls the size of an aperture inside the lens barrel. The smaller the iris, the less light that reaches the CCD sensor. The bigger the iris, the more light that reaches the CCD sensor. It is critical that NetCam's lens iris is set properly when pointing NetCam outdoors. The reason for this is twofold -- it provides much better image quality and it prevents permanent damage to the CCD sensor. If your lens has iris markings on it, adjust the iris to $f/16$ (the larger the f -stop, the smaller the iris). If your lens does not have numerical iris markings, look into the lens and visually watch the aperture change size as you turn the iris ring. You want to adjust the aperture until it is roughly the size of a pinhole.

Precisely Setting the Iris

- With NetCam in its permanent outdoor position, set the iris to the size of a pinhole.
- In the Overlay Properties page, add $\$e$ to the Text string.
- Monitor the live image. In bright daylight, the exposure should read between 100 and 500.
- If the exposure is less than 100, close the iris more. If the exposure is more than 500, try opening the iris slightly.
- Note: Make sure "Auto Exposure" is enabled. The iris setting is a one-time procedure.

The Sun

If possible, aim NetCam so that it never points directly into the sun. The best direction is north or south. If you must point the camera in a western or eastern direction, try to get as little sky as possible in the image. What you want to avoid is direct sunlight -- as with any camera, or your eyes for that matter, looking into the sun produces some of the worst images. It can also damage the CCD sensor over time, even with the iris set properly.

There are certain imaging factors that are not controllable. Depending on where the sun travels in relation to the camera, you may find that images look better in the morning than the afternoon or vice versa. This is just the reality of lighting and is normal.

The Sky, Backlighting and Dynamic Range

One thing you can do to control the quality of your images is to reduce the likelihood of backlighting. Backlighting occurs when the background of an image is significantly brighter than the foreground. One example is a group of buildings in front of a bright sky. Depending on the difference in brightness between the buildings and the sky, the buildings can become a dark silhouette against the sky. Most cameras, as well as the human eye, are unable to capture details in both the dark foreground and the bright background at the same time. Dynamic range is the term used to describe the amount of detail a camera is able to capture in both dark and light areas at the same time. NetCam has great dynamic range, but as is the case with most cameras, it has its limits.

Here are a few suggestions for reducing backlighting:

- Point NetCam so little or no sky is visible in the image.
- If you want sky in the image, point NetCam to the north (or south)
- Use gamma correction option on the Image Properties page to increase the details in shadowy areas of the image.

Indoor Lighting

The biggest advantage that indoor lighting offers is control. Unlike outdoor lighting, there is no need to worry about a travelling light source or a strongly backlit sky. However, that doesn't mean indoor lighting does not have its challenges. Here are some suggestions for improving indoor imaging.

- If light is limited, open the lens iris all the way.
- Avoid pointing the camera at regions with white walls in the background as this may produce an undesired backlighting effect.
- Avoid pointing the camera toward a window.
- If possible, avoid mixed light sources. For example, a room with

both fluorescent and halogen lights will illuminate the room with different color temperatures, which will be visible in the NetCam images.

4.2 Image Processing Options

The images produced by NetCam are processed and compressed inside the camera. Many options that affect the quality of the image are available on the Image Properties Page -- the important ones are listed here (for a complete list, see Chapter 2.1).

Brightness - This controls how the bright the auto exposure will adjust the image. When auto exposure is enabled (which it should be, especially when doing outdoor imaging), this is the main control you will need to adjust to increase or decrease the overall brightness of the live images. If your images are coming out dark during daylight (or indoor lighting), increase this value.

Saturation - This value represents the amount of color in the image. The higher the number, the more the saturated the colors become. The default value works well in most cases. If you do want more color saturation, increasing the number from its default of 1200 to 1300 should do the trick. Anything higher may start to produce undesired color effects.

Gamma - This adjusts the amount of detail visible in shadowy areas, at the expense of increased haziness. Try increasing the default value of 1700 to 1800 to see more details in dark areas. Or if you want more contrast, reduce it to between 1000 and 1500.

Sharpen - For the best quality images, this should always be left on.

JPEG Quality - The default value of 70 works well in most cases. The compression artifacts are minimal and the file size small. While increasing the quality will result in a slightly clearer image (less JPEG compression artifacts), the significantly increased file size hardly makes it worthwhile, especially when the quality is set to 90 or higher. Conversely, if you'd like images to download/upload faster for viewers with dial-up Internet connections, you can reduce the JPEG quality which decreases the file size. A value of 50 still results in good looking images at a very small file size.

Chapter 5 NetCam Lenses

The Focus Ring

NetCam ships with a pre-focused lens. Most lenses available for NetCam also have a focus ring which allows you to focus the lens for a closer subject. The focus ring may be marked in meters:

0.2m -- 0.3 -- 0.4 -- 0.5 -- 1.0 -- ∞

The ∞ stands for infinity. When NetCam leaves the factory, the infinity setting is back-focused for infinity. Turning the focus ring to 0.5 meters will yield a focus of half a meter. Turning it back to the infinity symbol will yield an infinite focus again.

Some lenses will not have the numerical markings -- they may be marked only with “near” and “far”. The “far” setting is infinity and the “near” setting is the closest the lens will be able to focus, which varies from lens to lens.

The Iris Ring

Most lenses available for NetCam come with a manually adjustable iris ring. In indoor lighting situations, you will *usually* want the iris open to its fullest position. In outdoor lighting, you will almost always want the iris set to its smallest position (*f*16 or smaller, pinhole-sized). The iris ring is usually marked in *f*-stops:

1.3 -- 4 -- 8 -- 16 -- C

The C stands for closed. In this example, the 16 setting is the smallest marked iris opening and 1.3 is the largest. You can set the iris to settings in between the marked numbers (setting it between 16 and C would result in a setting closer to *f*22, which is even smaller than *f*16).

Some lenses do not contain numerical iris markings, but will be marked with “open” and “close”. You will need to look in the lens to see the size of the iris when placing NetCam outdoors. Adjust the iris ring until the iris opening or aperture is the roughly size of a pinhole. We strongly recommend you tune the iris by following the instructions in section 4.1.

Changing Lenses

Change lenses usually requires a back focus adjustment of the new lens. Back focus is the adjustment of the chrome ring that the lens is screwed into. Follow these steps when replacing a lens.

1. Unscrew the original lens from the chrome back ring and completely remove it.
2. Determine if your lens is C-Mount or CS-Mount. If you ordered

it from StarDot, it will be noted on the packaging.

The only difference between a C-Mount lens and CS-Mount lens is the C-Mount lens requires a 5mm spacer between the lens and the chrome back-focus ring (the spacer is included with the standard 8mm C-Mount lens that ships with NetCam).

If your lens is CS-Mount, you do not need to use the included 5mm spacer. If your lens is C-Mount, unscrew the black 5mm spacer from the back of the 8mm lens and screw it onto the back of the C-Mount lens you will be installing on NetCam.

3. Screw the new lens (with attached spacer if the lens is C-Mount) into the chrome back focus ring on NetCam. Continue turning until the lens is a securely attached.
4. Set the lens focus ring is set to the infinity setting (∞).
5. Set the lens iris all the way open if indoors or to a pinhole size ($f16$) if outdoors.
6. Use a web browser to view the camera's live image. For the rough focus, you may want to select a low resolution like 160x120 so the images update faster.
7. Use the included Allen or hex wrench to loosen the back focus set screw on the bottom and/or top of the camera.
8. While watching the live image turn the entire lens assembly (lens, optional spacer, and chrome back focus ring) counterclockwise by 1/2 turn. Make sure the individual iris and focus rings do not get turned out of position. Focus must be in the infinity position and the iris all the way open for indoor lighting or set to a pinhole size for outdoor lighting.
9. Wait a few seconds for the live image to catch up to the focus change and see if the image gets clearer or blurrier. If it looks sharper, continue turning in the same direction until you get a rough focus. If the image looks blurrier, try turning one full turn clockwise.
10. Once you get a rough focus with the low-res image, set the resolution to 320x240 or 640x480 for your fine focus.
11. Focus on something across the room (or in distance outdoors) that has detail (i.e. lettering, a contrast-heavy pattern, etc.). Once you get a sharp focus, use the Allen or hex wrench to tighten the back-focus set screw. Do not overtighten.

Tip: *The key to focusing a lens on NetCam is to wait for at least three live images to update before evaluating the change.*

Troubleshooting Guide

The StarDot Tools software does not list NetCam on my local network and/or is not accessible via its IP address.

1. Double check all cable connections and make sure NetCam's network cable is plugged into an active Ethernet hub, switch or router. Make sure NetCam's power LED is on (amber on boot-up, then green).
2. Connect NetCam to a PC's serial port with the included null modem cable to verify network settings with the StarDot Tools software.

NetCam is slow to respond on a web browser.

1. If you have dial-up Internet connection, this may be normal.
2. Increase the applet refresh time, especially if the image resolution is set to the highest value. Try a value like 2000 or 3000 (2 or 3 seconds).
3. Set the JPEG quality to 70 or below. The higher the JPEG quality, the bigger the image file size, with very little improvement in image quality.

Images are not uploading to FTP server.

1. Double check all settings including hostname, username, password and path by using third party FTP client software (the command prompt FTP in Windows is a good test).
2. Try using an IP address in the hostname, or double check your DNS settings. For dial-up NetCam, do not use an IP address, use a hostname.
3. Try turning on the advanced FTP options "Delete Before Rename" and "IIS 4.0"
4. Telnet to NetCam and type `cd /etc/config` and press Enter. Type `ftp-script ftp.scr` and press Enter. Watch the results for errors.

Technical Support

Technical support for NetCam customers is available directly from StarDot Technologies. Answers to most questions can be found at our web site at <http://www.stardot-tech.com>.

[Technical Support and Software/Firmware Downloads](http://www.stardot-tech.com/netcam)

<http://www.stardot-tech.com/netcam>

[Technical Support via E-mail](mailto:help@stardot-tech.com)

help@stardot-tech.com

[Technical Support via Phone](tel:(714)228-9282)

(714) 228-9282, 9AM - 5PM PST, Monday-Friday

Specifications

TECHNICAL SPECIFICATIONS	
Image Sensor	NetCam - 640x480 Sharp 1/3" RGB Frame Transfer CCD NetCam MP - 1280x960 Sony 1/2" RGB Frame Transfer CCD
Sensitivity	2 LUX (with f1.2 iris)
Exposure	Auto exposure with brightness adjustment and grid exposure selection or manual exposure (1/50,000 second ~ 1.3 seconds)
Imaging Features	Auto/manual color balance (including skew override), contrast enhancement (haze subtraction, gamma correction) and sharpening
Image Compression	Industry Standard JPEG (adjustable quality/compression)
Frame Rate	96x80 (4 frames per second) 160x120 (2.5 frames per second) 192x160 (2 frames per second) 320x240 (1 frame per second) 640x480 (1 frame every 3 seconds) 1280x960 (1 frame every 8 seconds) - NetCam MP only
Typical File Sizes	320x240 (8~20KB) 640x480 (25~70KB) 1280x960 (50~120KB) - NetCam MP only
Network Connection	1 x 10-baseT Ethernet (10/100 compatible)
Network Protocols Supported	TCP/IP, HTTP, FTP, DHCP, PING, TELNET, DAYTIME, NTP, SMB, NFS
Serial Connection	2 x RS-232 Ports, DB9, up to 115.2Kb/sec
I/O Connectors	4 x Digital Alarm Inputs or 4 x 5V Swing Output Pins 1 x Fully Isolated Relay, 2A@5V or 0.5A@28VDC Output is 5VDC@50mA
Internal Operating System	uClinux
Security	Separate password-protected user accounts for administering the server and viewing the images, additional user accounts can be added
Operating Temperature	-40°F to +120°F (-40°C to +49°C)
Dimensions	3.25" wide (82.5 mm) x 2.20" high (56 mm) x 6.6" deep (167 mm)
Weight	19.5 ounces (553 grams)
EMI Approval	FCC Class A, CE (EN55024/1998, EN55022/1998)
Power Requirements	8VDC - 15VDC (500mA@12V)

FCC STATEMENT OF COMPLIANCE

This equipment has been tested and found to comply with the limits for a Class A digital device, pursuant to Part 15 of the FCC Rules. These limits are designed to provide reasonable protection against harmful interference when the equipment is operated in a commercial environment. This equipment generates, uses, and can radiate radio frequency energy and, if not installed and used in accordance with the instruction manual, may cause harmful interference to radio communications. Operation of this equipment in a residential area is likely to cause harmful interference in which case the user will be required to correct the interference at his own expense.

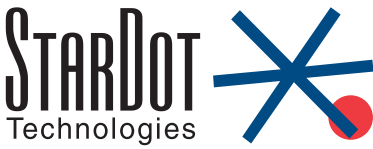

6820-H Orangethorpe Ave
Buena Park, CA 90620 U.S.A.
714-228-9282 • Fax: 714-228-9283
E-mail: info@stardot-tech.com
<http://www.stardot-tech.com>